



# **Chambers County Fire Marshal's Office** **Fire Department Connection (FDC) &** **Control Valve Installation**

## **APPLICABLE STANDARDS**

Applicable standards for all Automatic Sprinkler and Fire Alarm System installations shall include:

- International Fire Code 2018 edition;
- NFPA 13, 2016 edition;
- NFPA 70, 2017 edition;
- NFPA 72, 2016 edition.

## **REQUIREMENTS FOR UNINCORPORATED CHAMBERS COUNTY**

1. Buildings of tilt-wall construction or buildings 30' or greater in height must have the FDC remotely located, out of the collapse zone. The collapse zone is a distance away from the building equal to the height of the exterior wall on the side of the FDC.
2. Buildings not meeting the above criteria may have the FDC mounted on the exterior of the building wall.
3. The system must have an indicating type main control valve, preferably accessible from the exterior of the building (such as a Wall-Post Indicator). If the valve is located inside the building, it must be directly accessible via an exterior door (The door must be labeled CONTROL VALVE – AUTOMATIC SPRINKLERS). If an upright Post Indicator Valve (PIV) is used for the control valve, it must be located out of the collapse zone if the conditions in item 1 are present.
4. The potable water supply to automatic sprinkler and standpipe systems shall be protected against backflow as required by the *International Plumbing Code (IFC 912.6)*.
5. Fire Department Connections shall be "Siamese" 2 ½" (inch) NH connections with Knox locking caps. The connections must be located at least 24" (inches) from the ground and no more than 36" (inches) from the ground. The locking caps may be ordered from [www.knoxbox.com](http://www.knoxbox.com).  
**\*Note:** If the location is within the City of Baytown LPA or Baytown Fire Department response area, the connection must be a single 5" Storz with locking cap. These areas include the Chambers Town Center, areas along SH146, and CCIDs 1, 2, and 3.
6. All fire department connections must be located no more than 100 feet from a fire apparatus access road, and no more than 100 feet from an accessible fire hydrant.
7. The hydrant serving the FDC must not require the blocking of main driveways or access into the facility.
8. All FDCs must be identified by a sign (912.5).
9. All FDCs and PIVs subject to vehicle impact shall be equipped with impact protection per IFC 2018 (912.4.3/312). Posts shall be no closer than 36" to the FDC or PIV and shall not interfere with their operation.

**Remote FDC Detail:**

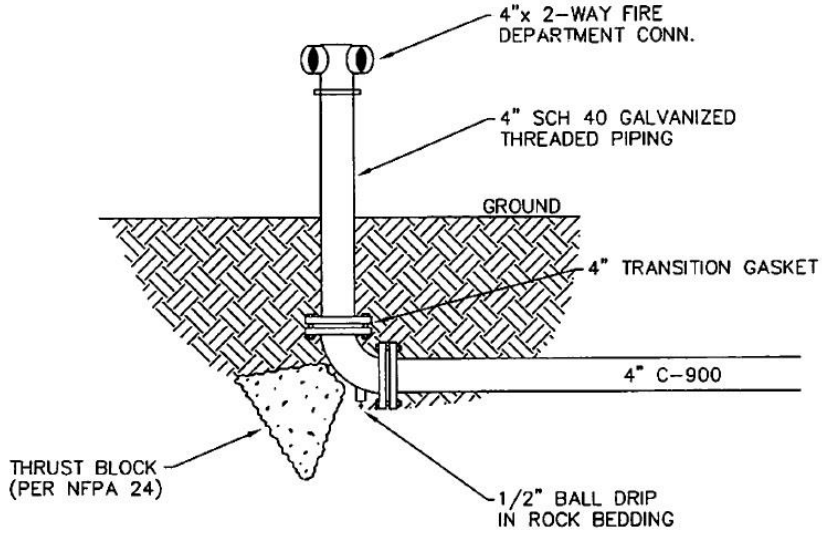

**REQUIREMENTS FOR CITY OF BAYTOWN LPA OR RESPONSE AREA\***

New buildings within the City of Baytown LPA or Baytown Fire Department response areas need to have an FDC compatible with the Baytown Fire Department. These areas include the Chambers Town Center, areas along SH146, Ameriport, and CCIDs 1, 2, and 3. The requirements for an FDC in these areas shall be all of the above requirements, with the following changes:

1. Fire Department Connections shall be a single 5” (inch) Storz connection with a Knox locking cap (Sec. 912.4.1).
2. The remote 5” Storz connection must be at a 30-degree downward angle to the ground and at least 24” (inches) from the ground and no more than 36” (inches) from the ground.
3. The 30-degree downward angle Storz connections and Knox locking caps may be ordered directly from [www.knoxbox.com](http://www.knoxbox.com).

**Remote FDC Detail (Baytown response area):**

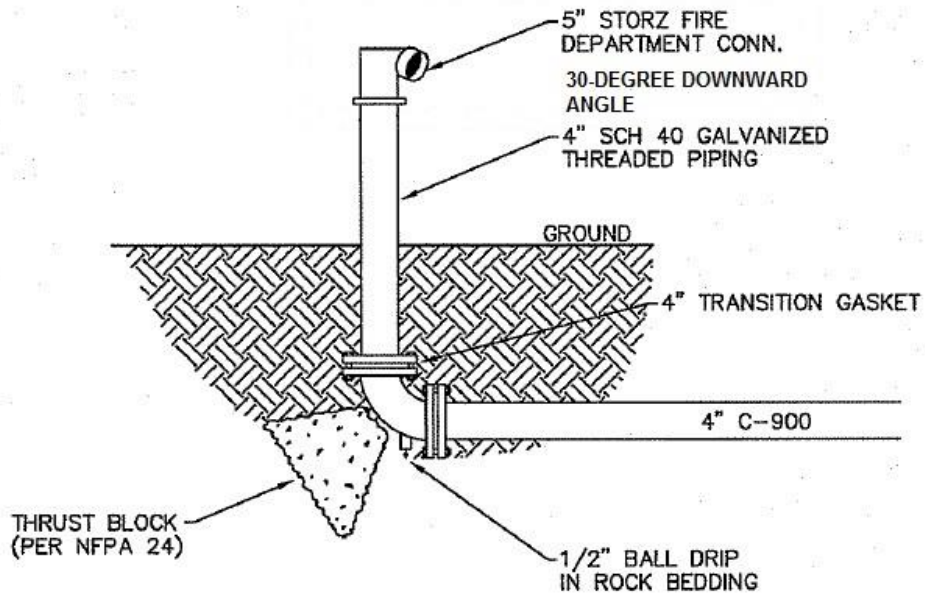

**FDC SIGNS**

1. All FDCs must be identified by a sign.
2. Signs shall be red with white letters, and be labeled with the letters FDC at least 6” high, and words in letters at least 2” high indicating the address of the facility.
3. All FDCs must also have a sign or placard with at least 1” high letters indicating the type of FDC. Such signs shall read: AUTOMATIC SPRINKLERS or STANDPIPES or TEST CONNECTION, or a combination of these words as applicable.
4. The sign must include the address of the facility it serves.
5. If the location of the FDC is not immediately obvious or visible from the street, a sign indicating the location of the FDC is also required. For example: FDC IN REAR, or FDC with an arrow indicating the location.

**EXAMPLES:**



and

**IF NECESSARY:**



or



**SPRINKLER CONTROL VALVE SIGNS**

1. If the control valve is located inside a building, it must be directly accessible via an exterior door.
2. The door must be labeled CONTROL VALVE – AUTOMATIC SPRINKLERS.

**EXAMPLE:**



3. If the control valve is located remotely and is not readily identifiable as pertaining to the building it serves, the address must be indicated on the sign as well.

**EXAMPLE:**



## **NFPA 13R SPRINKLER SYSTEM FDC REQUIREMENTS**

### MULTI-FAMILY DWELLINGS:

Chambers County requirements for NFPA 13R sprinkler systems on multi-family dwellings, (3 stories or less, only):

- 2 ½ inch fire department connection (FDC) is required to have a locking cap manufactured by the Knox Company.
- All FDC's shall be unobstructed (bushes, fence, etc.) and plainly visible from the fire department access road.
- All fire department connections shall be located no more than 100' (feet) from the fire department access road and no more than 100' (feet) from an accessible fire hydrant.
- A posted locator sign shall identify all fire department connections.
- The Locator sign shall be approximately 8" X 18".
  - a. The locator sign will have a RED background with reflective WHITE lettering.
  - b. First line - 6" letters (FDC)

The locator sign shall be mounted above the fire department connection, high enough so that it is not obstructed by bushes, fencing, vehicles, etc. and clearly visible from the fire department access road.

- Sprinkler riser rooms/closets shall be identified with a sign on the door.

